

bRite Standard Retail scale

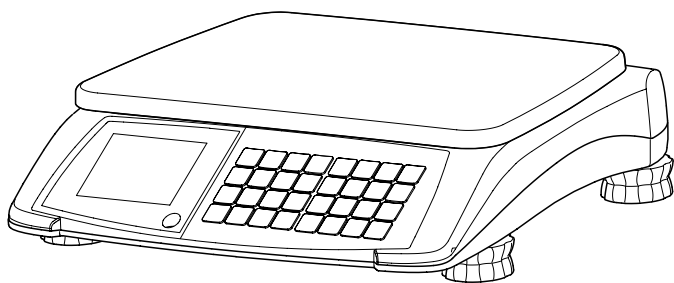

METTLER TOLEDO

Contents

1	Your new retail scale	4
1.1	Safety instructions	4
1.2	Further documents	4
1.3	Maintenance	4
1.4	Intended use	5
1.5	Device overview	5
1.6	Legal for Trade	8
2	Setting up	9
2.1	Requirements for scale's location	9
2.2	Levelling the scale	9
2.3	Inserting the batteries	10
2.4	Connecting to mains power	11
2.5	Turning scale on/off	11
3	Fast and easy operation	12
3.1	Free input	12
3.2	Calling up PLUs	13
3.3	Using tare	14
3.4	Zeroing	14
3.5	Cleaning	15
4	Technical data	16
4.1	Technical data	16
4.2	Compliance	16
5	Disposal	17

1 Your new retail scale

1.1 Safety instructions

Basic safety instructions

- Read these operating instructions prior to using your scale.
- Follow these operating instructions carefully.
- Store these operating instructions near the scale for future reference.
- Do not allow untrained personnel to operate or to clean the scale.
- Do not open the scale.
- Always unplug the scale before cleaning and maintenance.

Safety instructions for battery operation

- The battery must not come into contact with chemical solvents, oil or water.
- Keep batteries away from heat and fire.
- Do not open the battery.



CAUTION

Risk of explosion if the battery is replaced by an incorrect type

- ▶ Dispose of used batteries according to the instructions.

1.2 Further documents

- For further documents regarding your new retail scale (e.g., User Guide, Data Sheet) please refer to the following website:
<http://www.mt.com/retail-manuals>

1.3 Maintenance

- Only authorized personnel is allowed to open and repair the scale. Please contact your local representative.

1.4

Intended use

- Use the scale only for weighing in accordance with this manual.
- The scale is intended for use in dry locations only.
- Any other type of use and operation beyond the limits of the technical specifications is considered as not intended.

Misuse

- Do not use the scale in industrial and harsh environment.

1.5

Device overview

1.5.1

Keyboard

The keyboard is divided into four sections. The advanced function keys depend on the region.

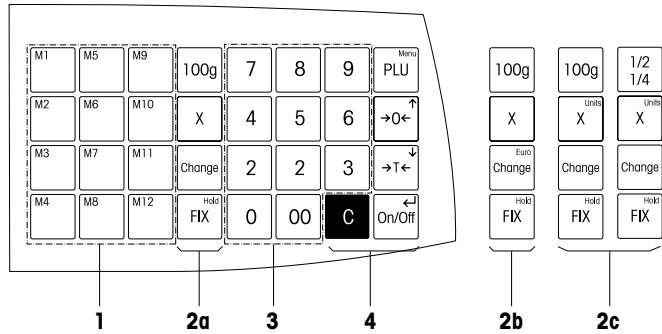

1 PLU preset keys

2a Advanced function keys, Basic (rest of the world)

2b Advanced function keys, Europe

2c Advanced function keys, versions for North America

3 Numeric keypad

4 Basic function keys

1.5.2

Display

The display is laid out as follows from the customer and vendor point of view:

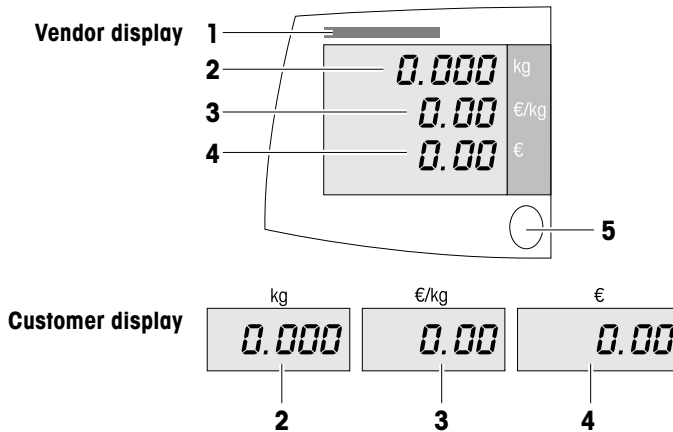

- 1 Calibration plate
- 2 Weight display
- 3 Unit price
- 4 Price
- 5 Level indicator

In addition to the weight and price, the following status messages and indicators can be displayed:

- | | |
|--------------|---|
| ZERO | Scale is at center of zero |
| PT | Keyboard tare or tare recalled from PLU |
| NET | Net value (gross minus tare); push button tare exists |
| FIX | Unit price and/or tare is fixed |
| X | Scale is in by-count mode |
| 100 g | 100 g pricing is activated |
| 1/2 | 1/2 lb pricing is activated |
| 1/4 | 1/4 lb pricing is activated |
| Add | Scale is in accumulation mode; data exists in the accumulation memory |
| Total | The displayed total price is added into the accumulation memory |
| | Battery is approx. full |
| | 2/3 battery power left |
| | 1/3 battery power left |
| | Battery power at a critical level |

1.5.3 Connections and features on the underside

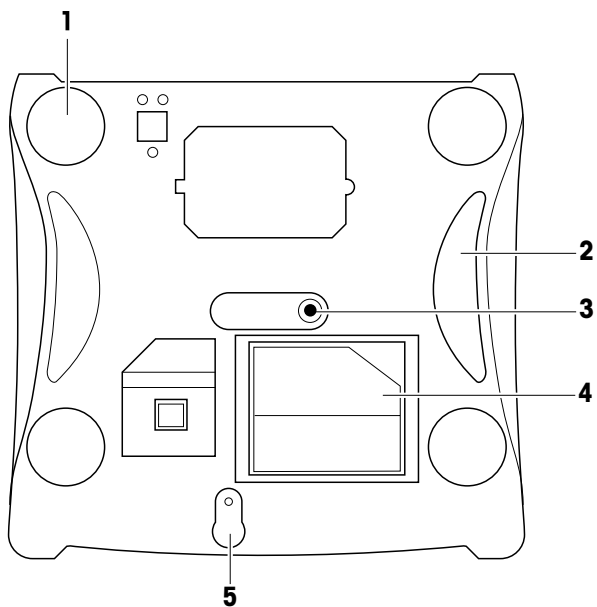

The following connections are located on the underside of the scale:

- 1** Adjustable feet
- 2** Grips
- 3** Power supply connection
- 4** Power supply storage box
- 5** Calibration button

1.6

Legal for Trade

When the scale is used in trade or a legally controlled application, it must be set up, verified and sealed in accordance with local weights and measures regulations. It is the responsibility of the purchaser to ensure that all pertinent legal requirements are met. As verification requirements vary by jurisdiction, the purchaser should contact their local weights and measures office if they are not familiar with the requirements.

For products sold in Europe, the verification process has been completed at the place of manufacture. These products have been sealed and the type plate includes supplemental metrology markings. They may be put into service immediately. If required by local W & M authorities, additional stickers will already be applied on the device.

For products sold in other regions, the verification process must be performed at the place of use.

To prevent access to calibration and metrological settings, the scale must be sealed using a paper seal or wire seal.

2 Setting up

2.1 Requirements for scale's location

The right location is critical to weighing accuracy.

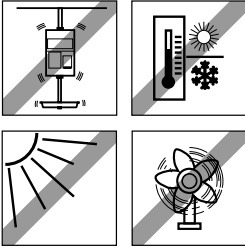

Conditions for an ideal location

- No shocks and vibrations
- No excessive temperature fluctuations
- No direct sunlight
- No strong drafts

► Select a stable, vibration-free and preferably horizontal location for your scale.

2.2 Levelling the scale

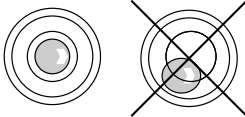

Only a perfectly levelled scale delivers accurate weighing results. The scale is equipped with a level indicator to make it easier to level the scale.

► To level the scale, turn the scale's adjustable feet until the air bubble in the level indicator is in the inner circle.

2.3

Inserting the batteries

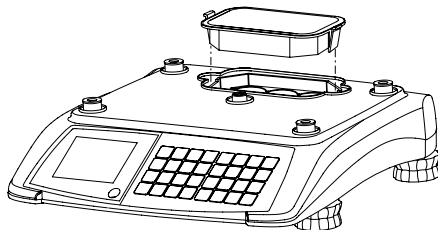

1. Make sure that the external power supply is disconnected.
2. Remove the weighing pan.
3. Remove the battery compartment cover.

**WARNING**

Damage to the battery if it is incorrectly installed.

- ▶ Pay attention to the correct battery polarity.
If the positive pole (+) and the negative pole (–) are connected wrongly, the display will show "-----".
After six seconds warning alarm, the scale will turn off automatically.
 - ▶ **Only use original manufacturer batteries.**
4. Place the battery in the compartment so that the terminal ends face upwards.
 5. Connect the red terminal end to the positive pole (red or +) and the black terminal end to the negative pole (black or –).
 6. Close the battery compartment.
 7. Put the weighing pan back on.



- The battery life is affected by charging and discharging conditions.
- If correctly used, the battery life can reach approx. 300 charging cycles.
- The battery's operating time is reduced when the battery has not been used over a longer period of time (two months).
- It is recommended that the battery be charged at least every 3 months.
- If the battery was not used over a longer period of time, then charge the battery at least three times and use it until it is completely discharged.
- The charging time decreases if the battery is not fully discharged.
- 6V Lead Acid batteries.

2.4

Connecting to mains power



DANGER

Electrical shock hazard

- ▶ Only connect the device to a properly grounded outlet.
- ▶ Only use the power cord supplied with the device.
- ▶ Use power outlets which are easily accessible and located no further than the length of the power cord.
- ▶ Do not remove the ground plug.

The power supply is stored in a compartment under the scale to support safe transport.

1. Connect the supplied power supply unit to the power connection socket on the underside of the scale.
2. Plug the power supply unit into a correctly grounded power outlet.

2.5

Turning scale on/off

- ▶ To turn the scale on press the **On/Off** key.
 - ▶ To turn the scale off press and hold the **On/Off** key until a long beep can be heard.
-
- After the scale is turned on, it runs through a short display test. All segments and status messages briefly light up, the software version is displayed.
 - The scale is ready when the weight display appears.



3

Fast and easy operation



The applications described in this chapter refer to working with one vendor.

3.1



0 ... 9

Free input

You can immediately use your scale for weighing and selling – without prior configuration.

1. Place the item on the scale.
2. Enter the unit price (price/kg).
The price to pay is displayed.
3. Remove the item from the scale.
All displays return to 0.



Enter the unit price as usual without the decimal point, but with all the decimal places.

3.2

Calling up PLUs

Depending on the setting of operator setup Step 7, there are two ways to call up PLUs.



0 ... 9 **PLU**

Calling up via PLU key (factory setting, operator setup Step 7 = OFF)

1. Place the item on the scale.
2. Enter the corresponding PLU number and press the **PLU** key. Unit price and price to pay are displayed.
3. Remove the item from the scale. All displays return to 0.



0 ... 9

Calling up PLU automatically (operator setup Step 7 = ON)

1. Place the item on the scale.
2. Enter the corresponding PLU number. The PLU is called up automatically. Unit price and price to pay are displayed.
3. Remove the item from the scale. All displays return to 0.



M1

Calling up PLUs with preset keys (operator setup Step 14 = OFF)

1. Place the item on the scale.
2. Press the corresponding preset key, e.g., **M1**. Unit price and price to pay are displayed.
3. Remove the item from the scale. All displays return to 0.

3.3

Using tare

You fill containers with your products or customers bring their own container. The tare function makes sure that only the goods are entered and paid.

If you know the weight of your containers, you can enter the tare weight via keyboard. So you do not have to tare the empty container.



...

Taring an empty container

1. Place the empty container on the scale.
2. Press the **Tare** key.
The weight display is reset to 0.000 kg and the NET symbol appears. The tare weight is displayed with negative sign in the first line of the display when the empty container is removed from the scale.
3. Fill the container with the goods to be weighed.
4. Carry out pricing as described above.
5. Remove the container from the scale.
All displays return to 0.

3.4

Zeroing

Due to soiling on the weighing pan or unfavourable external influences, it is possible that the weight display of an unloaded weighing pan may no longer be 0.000 kg. In such cases, the scale must be reset to zero. The maximum allowed deviation to be compensated by zeroing is +/- 2 % of the weighing range.

- ▶ Press the **Zero** key.

The weight display is set to zero.

0.010 kg



0.000 kg

3.5

Cleaning



CAUTION

Damage to the scale

- ▶ Turn off and unplug the device before cleaning.
- ▶ Do not open the device.
- ▶ Make sure that no fluids get inside the device.
- ▶ Do not use scouring powders or plastic dissolving cleaning agents for cleaning.

Cleaning

- ▶ Remove the weighing pan and clean it with a commercially available household detergent.
- ▶ If heavily soiled, clean the surface of the device with a damp cloth that has been dipped in water containing a mild liquid detergent and well wrung out.

4 Technical data

4.1 Technical data

Scale data	
Max. load / increments	3 kg / 1 g 6 kg / 2 g 15 kg / 5 g 30 kg / 10 g
Display	
Weight display	6 digits
Unit price display	6 digits
Total price display	6 digits
Ambient conditions	
Operating temperature	-10 °C to +40 °C
Storage temperature	-25 °C to +50 °C
Humidity	85 % max. relative, non-condensing
Altitude	up to 2000 m
Electrical data	
Power supply	100 to 240 V AC, 50/60 Hz
Mains supply voltage fluctuations	up to ±10 % of the nominal voltage
Installation category	II
Degree of pollution	2

4.2 Compliance



Compliance to the following standards is indicated by the corresponding mark on the product.

This product conforms to the EMC directive 2014/30/EU, the Low Voltage Directive 2014/35/EU and the Non-automatic Weighing Instruments Directive 2014/31/EU. The complete Declaration of Conformity is available online at

<http://www.mt.com/retail-manuals>

5

Disposal

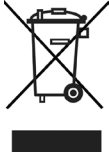

In accordance with the requirements of European Directive 2002/96 EC on Waste Electrical and Electronic Equipment (WEEE), this device may not be disposed of with domestic refuse. This also applies for countries outside the EU in accordance with their respective national regulations.

- ▶ Please dispose of this product in accordance with local regulations for the separate collection of waste electrical and electronic equipment.

Should you have any questions, please contact the corresponding authorities or the dealer from whom this device was purchased.

If this device is passed on (for example for further private or commercial/ industrial use), this regulation is also to be passed on.

Many thanks for your contribution to the protection of the environment.

Battery disposal Batteries contain heavy metals and therefore cannot be disposed of in the domestic refuse.

- ▶ Observe local regulations on the disposal of materials which are hazardous to the environment.



For disposal instructions in Europe, refer to

<http://www.mt.com/retail-manuals>

www.mt.com/service

For more information

Mettler-Toledo GmbH

Subject to technical changes
© 12/2015 Mettler-Toledo GmbH
Printed in Switzerland
Order number 30304442A

