

METTLER TOLEDO



This User Manual is a brief instruction that provides information to handle with the first steps of the instrument in a safe and efficient manner. Personnel must have carefully read and understood this manual before performing any tasks.

For full information, always consult the Reference Manual (RM).

► www.mt.com/JL-GE-RM

Overview balance

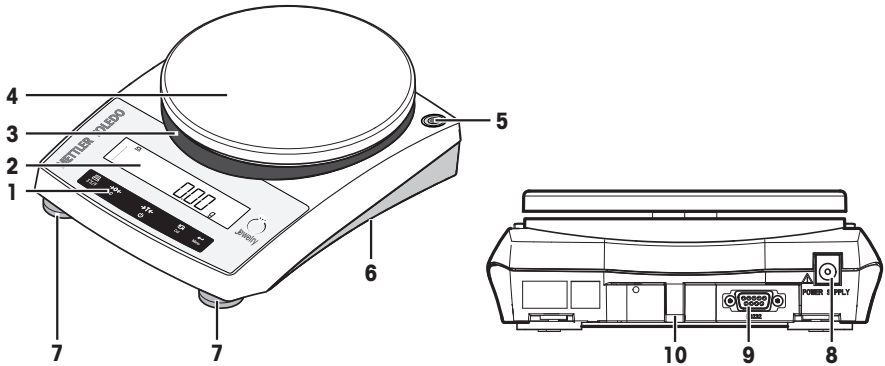

1	Operation keys	6	Bottom of balance: <ul style="list-style-type: none"> Battery compartment Weighing hook opening for weighing below the balance
2	Display	7	Leveling feet
3	Adapter ring	8	Socket for AC/DC adapter
4	Weighing pan	9	RS232C serial interface
5	Level indicator	10	Lug for anti-theft purposes

Overview operation keys

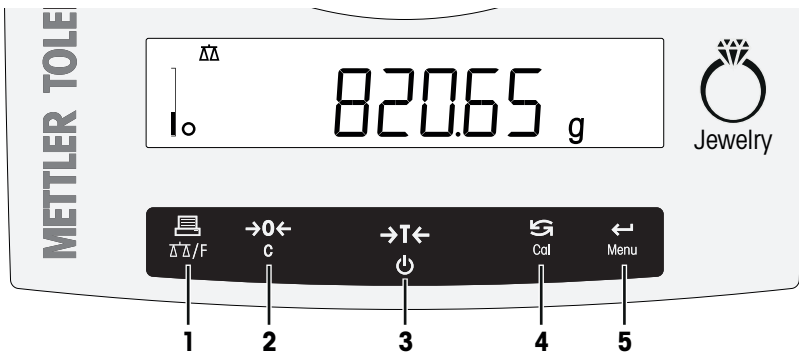

	Key	Press briefly (less than 1.5 s)	☞	Press and hold (longer than 1.5 s)	☞
1	 ΔΔ/F	<ul style="list-style-type: none"> Printout display value Transmit data To navigate backward in the menu or menu selection Decrease parameters in menu or applications 		<ul style="list-style-type: none"> Open the application list and scroll among the weighing applications in certain sequence for selecting an application Exits an active application and returns to the selection for weighing mode 	







	Key	Press briefly (less than 1.5 s) 	Press and hold (longer than 1.5 s) 
2	 C	<ul style="list-style-type: none"> Zero setting 	<ul style="list-style-type: none"> Cancel and leave menu without saving One step back in the menu Cancel or leave application setting
3	 	<ul style="list-style-type: none"> Tare Switch on 	<ul style="list-style-type: none"> Switch off
4	 Cal	<ul style="list-style-type: none"> With entries, scroll down To navigate forward menu topics or menu selections To toggle between unit 1, recall value (if selected), unit 2 (if different from unit 1) and the application unit (if any) Increase parameters in menu or applications 	<ul style="list-style-type: none"> Execute predefined adjustment (calibration) procedure
5	 Menu	<ul style="list-style-type: none"> Enter or leave menu selection To enter application parameter and switch to next parameter To store parameter 	<ul style="list-style-type: none"> Enter or leave menu (parameter settings)

Table of Contents

1	Introduction	3
1.1	Further documents and information	3
1.2	Acronyms and abbreviations	3
1.3	Compliance information	3
2	Safety Information	4
2.1	Definitions of signal words and warning symbols	4
2.2	Product-specific safety notes	4
3	Design and Function	5
3.1	Overview	5
3.2	Display	5
4	Installation and Putting into Operation	6
4.1	Selecting the location	6
4.2	Scope of delivery	7
4.3	Unpacking the balance	7
4.4	Installation	7
4.4.1	Assembling the balance	7
4.4.2	Installing the protective cover	8
4.4.3	Using batteries	8
4.4.3.1	Inserting or replacing batteries	9
4.5	Putting into operation	9
4.5.1	Connecting the balance	9
4.5.2	Switching on the balance	10
4.5.3	Leveling the balance	10
4.5.4	Adjusting the balance	11
4.5.4.1	Adjustment with external weight	12
4.6	Performing a simple weighing	12
4.7	Transporting, packing, and storing	15
4.7.1	Transporting over short distances	15
4.7.2	Transporting over long distances	15
4.7.3	Packing and storing	15
5	Maintenance	16
5.1	Maintenance tasks	16
5.2	Cleaning	16
5.2.1	Cleaning the balance	16
5.2.2	Putting into operation after cleaning	17
6	Technical Data	17
6.1	General data	17
7	Disposal	19

1 Introduction

Thank you for choosing a METTLER TOLEDO balance. The balance combines high performance with ease of use.

EULA

The software in this product is licensed under the METTLER TOLEDO End User License Agreement (EULA) for Software.

► www.mt.com/EULA

When using this product you agree to the terms of the EULA.

1.1 Further documents and information

This document is available in other languages online.

► www.mt.com/jewelry

Instructions for cleaning a balance: "8 Steps to a Clean Balance"

► www.mt.com/lab-cleaning-guide

Search for software downloads

► www.mt.com/labweighing-software-download

Search for documents

► www.mt.com/library

For further questions, please contact your authorized METTLER TOLEDO dealer or service representative.

► www.mt.com/contact

1.2 Acronyms and abbreviations

Original term	Explanation
ASTM	American Society for Testing and Materials
EMC	Electromagnetic Compatibility
FCC	Federal Communications Commission
GWP	Good Weighing Practice
ID	Identification
MT-SICS	METTLER TOLEDO Standard Interface Command Set
OIML	Organisation Internationale de Métrologie Légale (International Organization of Legal Metrology)
RM	Reference Manual
SNR	Serial Number
UM	User Manual
USB	Universal Serial Bus

1.3 Compliance information

National approval documents, e.g., the FCC Supplier Declaration of Conformity, are available online and/or included in the packaging.

► <http://www.mt.com/ComplianceSearch>

Contact METTLER TOLEDO for questions about the country-specific compliance of your instrument.

► www.mt.com/contact

United States of America

This equipment has been tested and found to comply with the limits for a **Class A** digital device, pursuant to part 15 of the FCC Rules. These limits are designed to provide reasonable protection against harmful interference when the equipment is operated in a commercial environment. This equipment generates, uses, and can radiate radio frequency energy and, if not installed and used in accordance with the instruction manual,

may cause harmful interference to radio communications. Operation of this equipment in a residential area is likely to cause harmful interference in which case the user will be required to correct the interference at his own expense.

Changes or modifications not expressly approved by the party responsible for compliance could void the user's authority to operate the equipment.

2 Safety Information

Two documents named "User Manual" and "Reference Manual" are available for this instrument.

- The User Manual is printed and delivered with the instrument.
- The electronic Reference Manual contains a full description of the instrument and its use.
- Keep both documents for future reference.
- Include both documents if you transfer the instrument to other parties.

Only use the instrument according to the User Manual and the Reference Manual. If you do not use the instrument according to these documents or if the instrument is modified, the safety of the instrument may be impaired and Mettler-Toledo GmbH assumes no liability.

2.1 Definitions of signal words and warning symbols

Safety notes contain important information on safety issues. Ignoring the safety notes may lead to personal injury, damage to the instrument, malfunctions and false results. Safety notes are marked with the following signal words and warning symbols:

Signal words

DANGER	A hazardous situation with high risk, resulting in death or severe injury if not avoided.
WARNING	A hazardous situation with medium risk, possibly resulting in death or severe injury if not avoided.
CAUTION	A hazardous situation with low risk, resulting in minor or moderate injury if not avoided.
NOTICE	A hazardous situation with low risk, resulting in damage to the instrument, other material damage, malfunctions and erroneous results, or loss of data.

Warning symbols



General hazard



Notice

2.2 Product-specific safety notes

Intended use

This instrument is designed to be used by trained staff. The instrument is intended for weighing purposes.

Any other type of use and operation beyond the limits of use stated by Mettler-Toledo GmbH without consent from Mettler-Toledo GmbH is considered as not intended.

Responsibilities of the instrument owner

The instrument owner is the person holding the legal title to the instrument and who uses the instrument or authorizes any person to use it, or the person who is deemed by law to be the operator of the instrument. The instrument owner is responsible for the safety of all users of the instrument and third parties.

Mettler-Toledo GmbH assumes that the instrument owner trains users to safely use the instrument in their workplace and deal with potential hazards. Mettler-Toledo GmbH assumes that the instrument owner provides the necessary protective gear.

Safety notes



WARNING

Death or serious injury due to electric shock

Contact with parts that carry a live current can lead to death or injury.

- 1 Only use the METTLER TOLEDO power cable and AC/DC adapter designed for your instrument.
- 2 Connect the power cable to a grounded power outlet.
- 3 Keep all electrical cables and connections away from liquids and moisture.
- 4 Check the cables and the power plug for damage and replace them if damaged.



NOTICE

Damage to the instrument or malfunction due to the use of unsuitable parts

- Only use parts from METTLER TOLEDO that are intended to be used with your instrument.

A list of spare parts and accessories can be found in the Reference Manual.



NOTICE

Damage to the instrument or software

In some countries, excessive mains voltage fluctuations and strong glitches may occur. This may affect the instrument functions or damage the software.

- Use a voltage regulator for stabilizing.

3 Design and Function

3.1 Overview

See the sections "Overview" (graphics and legend) at the very beginning of this manual.

3.2 Display

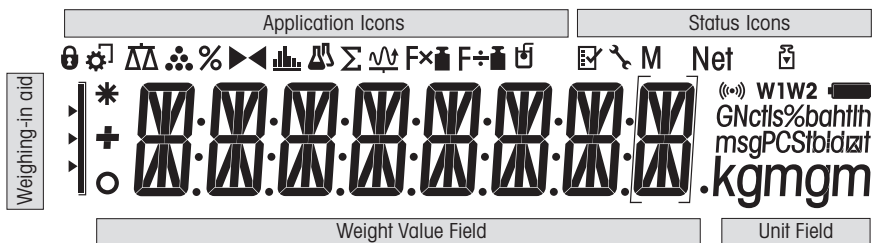

Application icons			
	Application weighing		Application totaling
	Application piece counting		Application multiplication factor
	Application percent weighing		Application division factor
	Application check weighing		Menu locked
	Application statistics		

While an application is running, the corresponding application icon appears at the top of the display.

Status icons			
M	Indicates stored value (Memory)		Feedback for pressed keys
Net	Indicates net weight values		Service reminder
	Adjustments (calibration) started		

Weight value field and weighing-in aid			
	Brackets to indicate uncertified digits (approved models only)		SmartTrac (weighing-in aid) shows how much of the entire weighing range has been used.
	Indicates negative values		Marking of nominal or target weight
	Indicates unstable values		Marking of tolerance limit T+
	Indicates calculated values		Marking of tolerance limit T-

Unit field						
GNctls%bahtlh msgPCStbidzaf kgmgm	g	gram	ozt	troy ounce	tls	Singapore taels
	kg	kilogram	GN	grain	tlf	Taiwan taels
	mg	milligram	dwt	pennyweight	tola	tola
	ct	carat	mom	momme	baht	baht
	lb	pound	msg	mesghal		
	oz	ounce	tlh	Hong Kong taels		

4 Installation and Putting into Operation

4.1 Selecting the location

A balance is a sensitive precision instrument. The location where it is placed will have a profound effect on the accuracy of the weighing results.

Requirements of the location

Place indoors on stable table

Ensure sufficient spacing

Level the instrument

Provide adequate lighting table

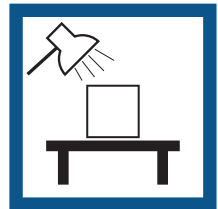
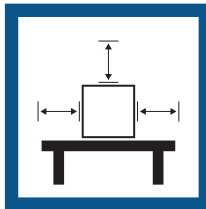

Avoid direct sunlight

Avoid vibrations

Avoid strong drafts

Avoid temperature fluctuations

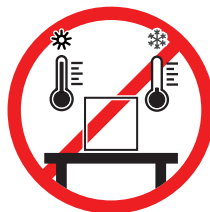
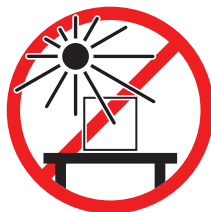

Sufficient distance: > 15 cm at the rear and side of the balance.

Take into account the environmental conditions. See "Technical Data".

4.2 Scope of delivery

- Balance
- Weighing pan and weighing pan support
- Protective cover for load cell cone (mounted)
- Protective cover (mounted)
- Stackable cover
- Universal AC/DC adapter (country specific)
- User Manual
- Declaration of Conformity

4.3 Unpacking the balance

Open the balance packaging. Check the balance for transport damage. Immediately inform a METTLER TOLEDO representative in the event of complaints or missing accessories.

Retain all parts of the packaging. This packaging offers the best possible protection for transporting the balance.

4.4 Installation

4.4.1 Assembling the balance

- 1 Remove the protective cover for the weighing cone (1).
Keep it for later use.
- 2 Place the pan support (2) on the balance.
- 3 Place the weighing pan (3) on pan support (2).

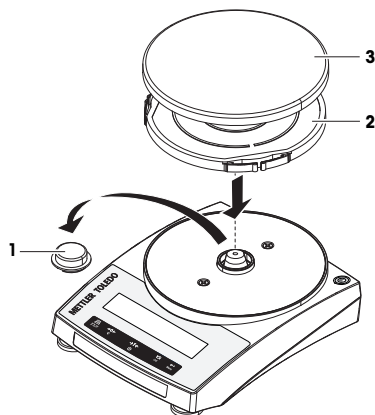

4.4.2 Installing the protective cover

- Install the protective cover according to the illustration, using a screwdriver.

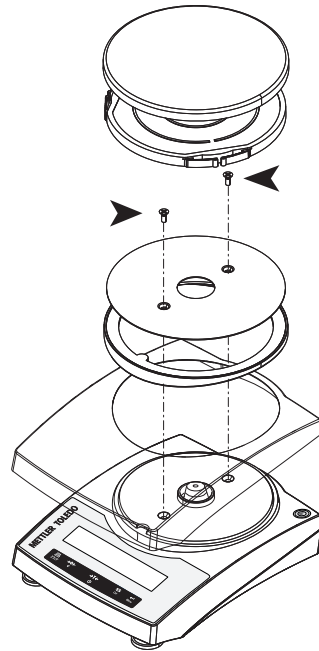

4.4.3 Using batteries

The balance can also operate with batteries. Under normal operation conditions, the balance works independently of the AC power line for about 8 to 15 hours (using alkaline batteries).

Immediately after the AC power supply is interrupted, e.g., by withdrawing the power plug or if there is a power failure, the balance switches automatically to battery operation. Once the AC power supply is restored, the balance reverts automatically to AC operation.

It is also possible to use rechargeable batteries. Charging batteries inside the balance is **not** possible.

Your balance uses 4 standard AA (LR6) batteries (alkaline batteries preferred).

When the balance is operating on its batteries, the battery symbol in the display lights up. The number of segments that are lit is an indicator of battery condition (3 = fully charged, 0 = discharged). When the batteries are almost completely discharged, the battery symbol flashes.



battery full



2/3 full



1/3 full



battery empty

4.4.3.1 Inserting or replacing batteries



⚠ WARNING

Death or serious injury due to electric shock

Contact with parts that contain a live current can lead to injury and death.

- Disconnect the instrument from the power supply when replacing the batteries.

- Read and follow all warnings and instructions supplied by the battery manufacturer.
- Do not mix different types or brands of batteries. Performance of batteries varies depending on the manufacturer.
- Remove the batteries from the balance if the balance is not used for a long period of time.
- Batteries must be disposed of properly, according to local regulations.

Proceed as follows:

- Make sure that the balance is switched off before removing or inserting batteries.
- 1 Remove weighing pan and pan support.
 - 2 Turn the balance carefully on its side.
 - 3 Open and remove the battery-chamber cover.
 - 4 Insert / replace the batteries with the correct polarity as shown in the battery holder.
 - 5 Insert and close the battery-chamber cover.
 - 6 Turn the balance carefully to its normal position.
 - 7 Reinstall all components in the reverse order.

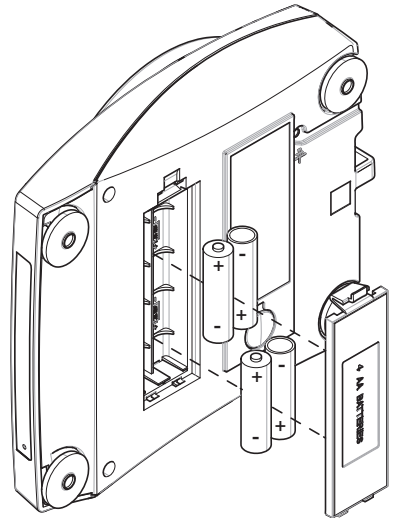

4.5 Putting into operation

4.5.1 Connecting the balance



⚠ WARNING

Death or serious injury due to electric shock

Contact with parts that carry a live current can lead to death or injury.

- 1 Only use the METTLER TOLEDO power cable and AC/DC adapter designed for your instrument.
- 2 Connect the power cable to a grounded power outlet.
- 3 Keep all electrical cables and connections away from liquids and moisture.
- 4 Check the cables and the power plug for damage and replace them if damaged.



NOTICE

Damage to the AC/DC adapter due to overheating

If the AC/DC adapter is covered or in a container, it is not sufficiently cooled and will overheat.

- 1 Do not cover the AC/DC adapter.
- 2 Do not put the AC/DC adapter in a container.

- Install the cables so that they cannot be damaged or interfere with operation.
- Insert the power cable in a grounded power outlet that is easily accessible.

- 1 Connect the AC/DC adapter (1) to the connection socket on the back of your balance.
- 2 Connect the power cable (2) to the power socket.
 - ➔ The balance performs a display test (all segments in the display light up briefly), **WELCOME, Software version, Maximum load** and **Readability** appears briefly.
 - ➔ The balance is ready to be used.

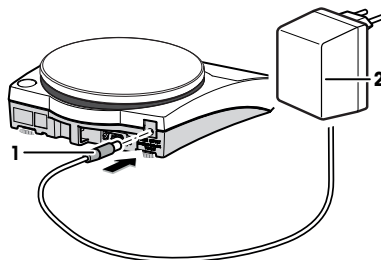

Note

Always connect the AC/DC adapter to the balance before connecting to the power.

Do not connect the instrument to a power outlet controlled by a switch. After switching on the instrument, it must warm up before giving accurate results.

4.5.2 Switching on the balance

Before using the balance, it must be warmed up in order to obtain accurate weighing results. To reach operating temperature, the balance must be acclimatized and connected to the power supply for at least 30 minutes.

Operation using a power supply (standby mode)

- The balance is connected to the power supply.
- 1 Remove any load from the weighing pan.
 - 2 Press 
 - ➔ The balance performs a display test. All segments in the display light up briefly, **WELCOME, Software version, Maximum load** and **Readability** appears briefly.
 - ➔ The balance is ready for weighing or for operation with the last active application.

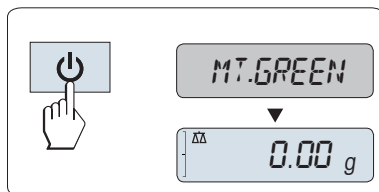

Operation using batteries

- 1 Remove any load from the weighing pan.
- 2 Press 
 - ➔ The balance performs a display test (all segments in the display light up briefly), **WELCOME, Software version, Maximum load** and **Readability** appears briefly.
 - ➔ After the warm-up time, the balance is ready for weighing or for operation with the last active application.

Legal-for-trade

Approved balances will execute an initial zero.

4.5.3 Leveling the balance

Exact horizontal and stable positioning are essential for repeatable and accurate weighing results.

There are four adjustable leveling feet to compensate for slight irregularities in the surface of the weighing bench.

The balance must be leveled and adjusted each time it is moved to a new location.

- 1 Position the balance at the selected location.
- 2 Align the balance horizontally.
- 3 Turning the leveling feet of the housing until the air bubble is in the middle of the glass.

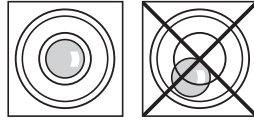

- 4 In this example, turn the left leveling feet counterclockwise.

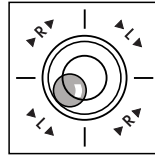

Example

Air bubble at 12 o'clock:



turn both feet clockwise.



Air bubble at 3 o'clock:



turn left foot clockwise, right foot counterclockwise.



Air bubble at 6 o'clock:



turn both feet counterclockwise.



Air bubble at 9 o'clock:



turn left foot counterclockwise, right foot clockwise.



4.5.4 Adjusting the balance

To obtain accurate weighing results, the balance must be adjusted to match the gravitational acceleration at its location. This is also dependent on the ambient conditions. After reaching the operating temperature, it is important to adjust the balance in the following cases:

- Before the balance is used for the first time.
- If the balance has been disconnected from the power supply or in the event of power failure.
- After significant environmental changes, e.g., temperature, humidity, air draft or vibrations.
- At regular intervals during weighing service.

4.5.4.1 Adjustment with external weight

Legal-for-trade

Approved models must be adjusted at the place of operation. Before putting in operation, and depending on particular country certification legislation, the balance will then have to be checked and sealed by authorized personnel.

- In the menu topic **CAL** (Adjustment) of advanced menu **ADJ.EXT** must be selected.
 - Required adjustment weight is ready.
 - Weighing pan is unloaded.
- 1 Press and hold **CAL** to execute external adjustment.
 - ➔ The required (predefined) adjustment weight value flashes on the display.
 - 2 Place adjustment weight in center of pan.
 - ➔ The balance adjusts itself automatically.
 - 3 Remove adjustment weight, when **0.00 g** flashes.
- ➔ The adjusting is finished when the message **ADJ DONE** appears briefly on the display. The balance returns to the last active application and is ready for operation.

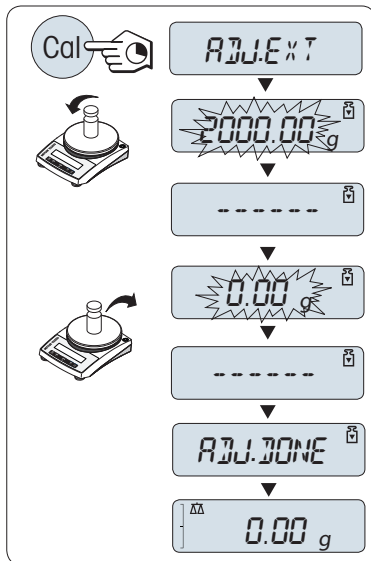

4.6 Performing a simple weighing



The weighing application allows you to perform simple weighings and how you can accelerate the weighing process.

If your balance is not in the weighing mode, press and hold the $\Delta\Delta/F$ key down until **WEIGH** appears in the display. Press \leftarrow . Your balance is in the weighing mode.

- 1 Press $\rightarrow 0 \leftarrow$ to zero the balance.
- 2 Place the sample on the weighing pan.
- 3 Wait until the instability detector \circ disappears.
- 4 Read the result.

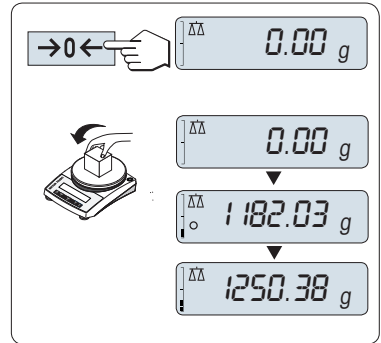

Zeroing

Use the $\rightarrow 0 \leftarrow$ zeroing key before you start with a weighing.

- 1 Unload the balance.
- 2 Press $\rightarrow 0 \leftarrow$ to zero the balance.
 - ➔ All weight values are measured in relation to this zero point.

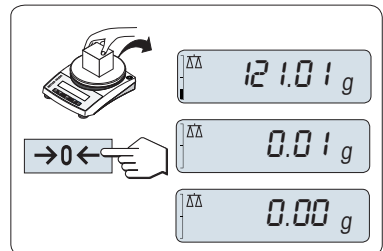

Taring

If you are working with a weighing container, first set the balance to zero.

- 1 Place empty container on the weighing pan.
 - ➔ The weight is displayed.
- 2 Press $\rightarrow T \leftarrow$ to tare the balance.
 - ➔ **0.00 g** and **Net** appears in the display. **Net** indicates that all weight values displayed are net values.
- 3 Place the sample in the container.
 - ➔ The result appears in the display.

If the container is removed from the balance, the tare weight will be shown as a negative value.

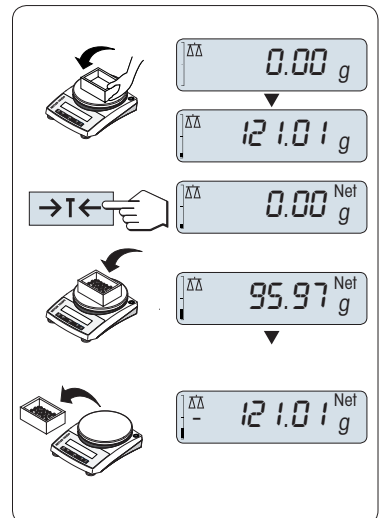

Switching weight units

The  key can be used at any time to toggle between weight unit **UNIT 1**, **RECALL** value (if selected) and weight unit **UNIT 2** (if different from weight unit 1) and the application unit (if any).

- Press  to set weight unit or recall value.

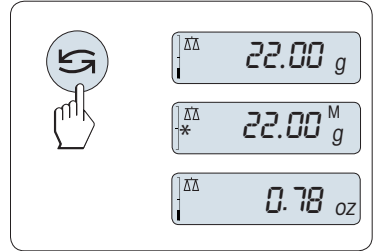

Recall / recall weight value

Recall stores stable weights with an absolute display value bigger than 10d.

- Function **RECALL** is in the menu activated.
- 1 Load weighing sample.
 - ➔ The display shows weight value and stores stable value.
 - 2 Remove weighing sample.
 - ➔ The display shows zero.
 - 3 Press .
 - ➔ The display shows last stored stable weight value for 5 seconds together with asterisk (*) and memory (M) symbols. After 5 seconds the display goes back to zero. This can be repeated unlimited times.

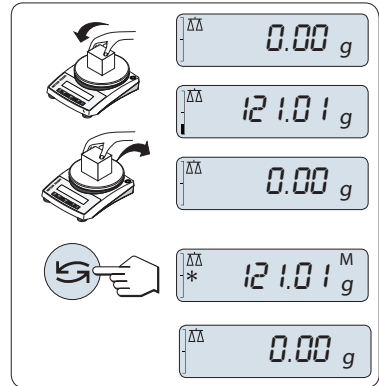

Delete last weight value

As soon as a new stable weight value is displayed, the old recall value becomes replaced by the new weight value.

- Press $\rightarrow 0/T \leftarrow$.
 - ➔ The recall value is set to 0.

If the power is switched off, the recall value is lost. The recall value can not be printed.

Weighing with the weighing-in aid

The weighing-in aid is a dynamic graphic indicator which shows the used amount of the total weighing range. You can thus recognize at a glance when the load on the balance approaches the maximum load.

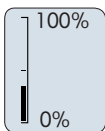

Print / transmit data

Press the  key to transmit the weighing results over the interface, e.g., to a printer or a computer.

4.7 Transporting, packing, and storing

4.7.1 Transporting over short distances

To move the balance over a short distance to a new location, follow the instructions below.

- 1 Disconnect the balance from the AC/DC adapter.
- 2 Disconnect all interface cables.
- 3 Hold the balance with both hands.
- 4 Carefully lift the balance and carry it to its new location.

If you wish to put the balance into operation, proceed as follows:

- 1 Connect in reverse order.
- 2 Level the balance.
- 3 Perform an adjustment.

4.7.2 Transporting over long distances

To transport the balance over long distances, always use the original packaging.

4.7.3 Packing and storing

Packing

Store all parts of the packaging in a safe place. The elements of the original packaging are developed specifically for the balance and its components to ensure maximum protection during transportation or storing.

Storing

Store the balance under following conditions:

- Indoor and in the original packaging.
- According to the environmental condition, see "Technical data".
- When storing for longer than two days, the backup battery may be down (date and time get lost).

Using the stackable cover

The stackable cover can be placed on the balance. It protects the balance from dust when it is not used and allows you to stack up a maximal number of 5 balances.

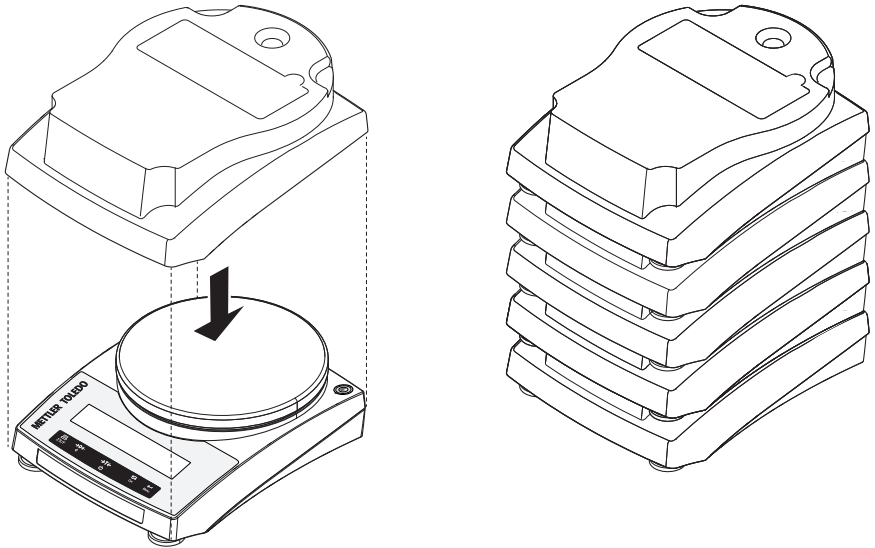

5 Maintenance

To guarantee the functionality of the balance and the accuracy of the weighing results, a number of maintenance actions must be performed by the user.

5.1 Maintenance tasks

Maintenance action	Recommended interval	Remarks
Performing an adjustment	<ul style="list-style-type: none">• Daily• After cleaning• After leveling• After changing the location	see "Adjusting the balance"
Cleaning	<ul style="list-style-type: none">• After every use• After changing the sample• Depending on the degree of pollution• Depending on your internal regulations (SOP)	see "Cleaning the balance"
Performing routine test / repeatability test.	<ul style="list-style-type: none">• After cleaning• After assembling the balance• Depending on your internal regulations (SOP)	see "Putting into operation after cleaning"

5.2 Cleaning

5.2.1 Cleaning the balance



NOTICE

Damage due to improper cleaning

Improper cleaning can damage the load cell or other essential parts.

- 1 Do not use any cleaning agents other than the ones specified in the "Reference Manual" or "Cleaning Guide".
- 2 Do not spray or pour liquids on the instrument. Always use a moistened lint-free cloth or a tissue.
- 3 Always wipe out from inside to outside of the instrument.



For further information on cleaning a balance, consult "8 Steps to a Clean Balance".

► www.mt.com/lab-cleaning-guide

Cleaning around the balance

- Remove any dirt or dust around the balance and avoid further contaminations.



Cleaning the removable parts

- Clean the removed part with a damp cloth or a tissue and a mild cleaning agent.

Cleaning the balance

- 1 Disconnect the balance from the AC/DC adapter.
- 2 Use a lint-free cloth moistened with a mild cleaning agent to clean the surface of the balance.
- 3 Remove powder or dust at first with a disposable tissue.
- 4 Remove sticky substances with a damp lint-free cloth and a mild solvent.

5.2.2 Putting into operation after cleaning

- 1 Reassemble the balance.
- 2 Press  to switch on the balance.
- 3 Warm up the balance. Wait 1 h for the acclimatization before starting the tests.
- 4 Check the level status, level the balance if necessary.
- 5 Perform an adjustment.
- 6 Perform a routine test according to the internal regulations of your company. METTLER TOLEDO recommends performing a repeatability test after cleaning the balance.
- 7 Press /T  to zero the balance.
⇒ The balance is ready to be used.

See also

 Adjusting the balance ▶ Page 11

6 Technical Data

6.1 General data

Standard power supply

AC/DC adapter:	Input: 100 – 240 V AC ± 10%, 50 – 60 Hz, 0.5 A Output: 12 V DC, 1.0 A (with electronic overload protection)
Balance power consumption:	12 V DC, 0.84 A
Polarity:	
Mean sea level:	Can be used up to 2000 m above mean sea level If the balance is used above 2000 m mean sea level, the optional power supply must be used.
Battery operation:	8 standard AA batteries (alkaline or lithium) for 8 – 15 hours of use

Optional power supply

AC/DC adapter:	Input: 100 – 240 V AC ± 10%, 50 – 60 Hz, 0.8 A Output: 12 V DC, 2.5 A (with electronic overload protection)
Cable for AC/DC adapter:	3-core, with country-specific plug
Balance power consumption:	12 V DC, 0.84 A
Mean sea level:	Can be used up to 4000 m above mean sea level

Protection and standards

Overvoltage category:	II
Degree of pollution:	2
Protection:	Protected against dust and water
Standards for safety and EMC:	See Declaration of Conformity
Range of application:	Use only indoors in dry locations

Environmental conditions

Height above mean sea level:	Depending on the power adapter (up to 2000 or 4000 m)
Ambient temperature:	Operating conditions for ordinary lab application: +10 °C to +30 °C (operability guaranteed between +5 °C and +40 °C)
Relative air humidity:	Max. 80% up to 31 °C, linearly decreasing to 50% at 40 °C, non-condensing

Warm-up time:

At least **30 minutes** after connecting the balance to the power supply. When switched on from standby, the instrument is ready for operation immediately.

Materials

Housing:

ABS/PC

Weighing pan:

Stainless steel X5CrNi 18-10 (1.4301)

7 Disposal

In conformance with the European Directive 2012/19/EU on Waste Electrical and Electronic Equipment (WEEE) this device may not be disposed of in domestic waste. This also applies to countries outside the EU, per their specific requirements.



Please dispose of this product in accordance with local regulations at the collecting point specified for electrical and electronic equipment. If you have any questions, please contact the responsible authority or the distributor from which you purchased this device. Should this device be passed on to other parties, the content of this regulation must also be related.

Battery disposal

Batteries contain heavy metals and therefore cannot be disposed of in the normal refuse.

- Observe local regulations on the disposal of materials that are hazardous to the environment.

GWP®

Good Weighing Practice™

GWP® is the global weighing standard, ensuring consistent accuracy of weighing processes, applicable to all equipment from any manufacturer. It helps to:

- Choose the appropriate balance or scale
- Calibrate and operate your weighing equipment with security
- Comply with quality and compliance standards in laboratory and manufacturing

 www.mt.com/GWP

www.mt.com/jewelry

For more information

Mettler-Toledo GmbH

Im Langacher 44
8606 Greifensee, Switzerland
www.mt.com/contact

Subject to technical changes.
© Mettler-Toledo GmbH 12/2020
30356946F en



30356946